

S7-C

Socket for miniature relays C7-... and C80 series time relays

Type:	S7-C 2-pole, 1 level integrated clip and marking label suitable for clips C80 series time relays coil bridge bus bar to connect in A2 plug-in slot for overvoltage suppressing units
--------------	--

Rated current	10 A
----------------------	-------------

Specifications	
Rated load	10 A / 250 V
Insulation	Test voltage V_{rms} / 1 min
- All terminal/DIN rail	2.5 kV
- Terminal/terminal	2.5 kV
Cross section of connecting wire	
- Single wire	4 mm ² , 2 x 1,5 mm ²
- Multi wire	2,5 mm ² / AWG 16, 2 x 1 mm ² / AWG 18
Max. screw torque	0.7 Nm
Screw dimensions	M3, Pozi, slot
Integrated retaining clip/plastic	for relays C7
Labelling space	detachable
Connection label	1 ... 8, DIN/EN
Mounting	DIN rail TS35 or mounting plate
Ambient temperature operation/storage	-40 (no ice) ... 60 °C / -40 ... 80 °C
Weight	37g

Associated plug-in 8-pin QRC relays	C7-A2x, C7-T, C7-G, C7-X, C7-W, C7-H
Associated C80 time relays	C83, C85, 84

Accessories	
Coil bridge bus bar	S7-B
Retaining clip, plastic	CP-09B

Please note:
This socket replaces former socket S7-M fully compatible

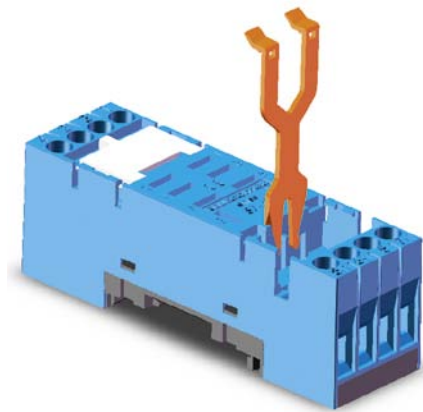

Connection diagram

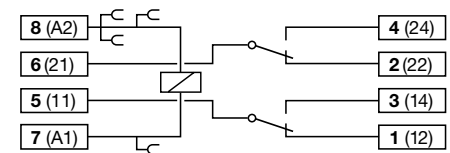

Dimensions [mm]

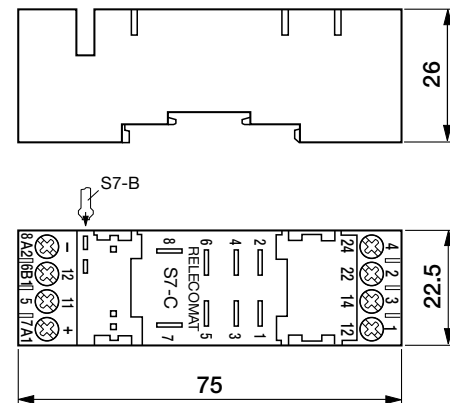

Technical approvals, conformities



Type	S7-I/O 2-pole, 2 level Integrated clip and marking label Coil bridge bus bar to connect in A2 Logic wiring
Rated current	10 A
Specifications	
Rated load	10 A / 250 V
Insulation	Test voltage V rms / 1 min
- All terminals/DIN rail	2,5 kV
- Terminal/terminal	2,5 kV
Cross-section of connecting wire	
- Single-wire	4 mm ² or 2 x 2,5 mm ²
- Multi-wire	22 - 14 AWG
Max. screw torque	1,2 Nm
Screw dimensions	M3, Pozi, slot
Integrated retaining clip/plastic	for relay series C7
Labelling space	detachable
Connection label	1...8; DIN/EN
Mounting	DIN rail TS35 or mounting plate
Ambient temperature operation/storage	-40 (no ice)...60 °C / -40 ... 80 °C
Weight	38g

Associated, plug-in 8-pin QRC relays **C7-A2x, C7-T, C7-G, C7-X, C7-W, C7-H**

Accessories
Coil bridge bus bar **S7-B**
Retaining clip, plastic **CP-01B**

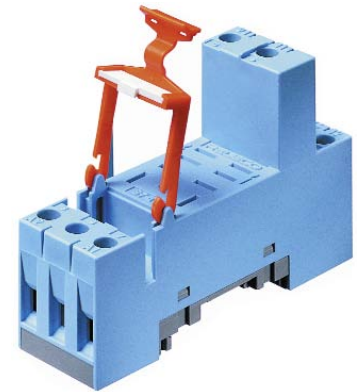

Connection diagram

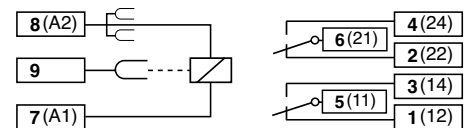

Dimensions [mm]

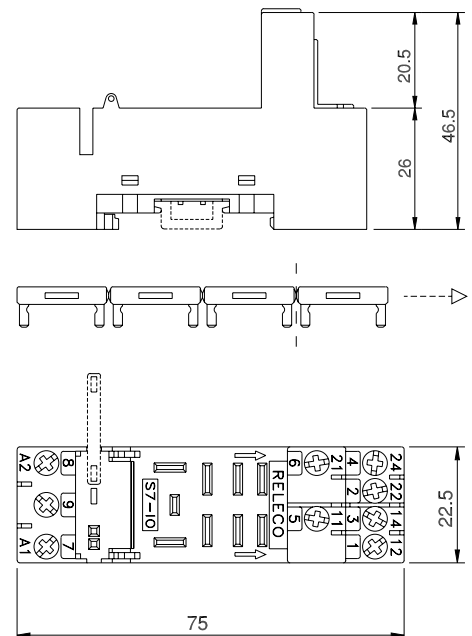

Technical approvals, conformities



EN 60947-1, EN 61810-1

Type	S7-16 1-pole, 1 level Integrated retaining clip and labelling space
Rated current	16 A
Specifications	<p>Rated load 16 A / 250 V</p> <p>Insulation Test voltage V rms / 1 min – All terminals/DIN rail 2,5 kV – Terminal/terminal 2,5 kV</p> <p>Cross-section of connecting wire – Single-wire 4 mm² or 2 x 2,5 mm² – Multi-wire 22 - 14 AWG</p> <p>Max. screw torque 1,2 Nm</p> <p>Screw dimensions M3, Pozi, slot</p> <p>Integrated retaining clip/plastic for relay series C7-A10</p> <p>Labelling space detachable</p> <p>Connection label 1...8; DIN/EN</p> <p>Mounting DIN rail TS35 or mounting plate</p> <p>Ambient temperature operation/storage -40 (no ice)...60 °C / -40 ... 80 °C</p> <p>Weight 31g</p>
Associated, plug-in 5-pin QRC relays	C7-A10
Accessories	CP-07B Retaining clip, plastic

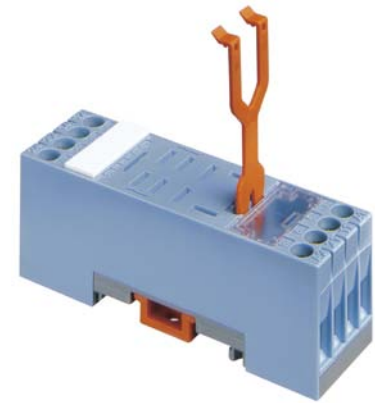

Connection diagram

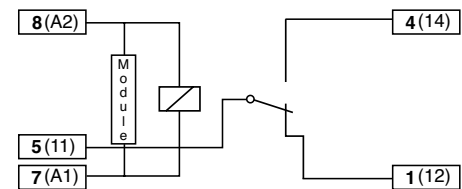

Dimensions [mm]

S7-16 for relays C7-A10 (16 A)

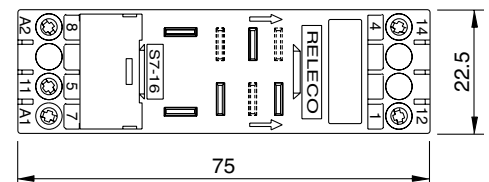
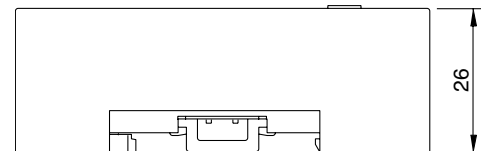

Technical approvals, conformities



EN 60947-1, EN 61810-1

Type	<p>S7-L 2-pole, flange panel mountable</p> <p>S7-P 2-pole, printed circuit</p> <p>S7-PO 2-pole, printed circuit with flange</p>
Rated current	10 A
Specifications	<p>Rated load 10 A / 250 V</p> <p>Dielectric strength adjacent pin 2.5 kV rms / 1 min</p> <p>Connection label 1...8; DIN/EN</p> <p>Integrated retaining clip/plastic for relay series C7</p> <p>S7-P: (CP-07B) S7-L + S7-PO: (CP-01B)</p> <p>Ambient temperature operation/storage -40 (no ice)...60 °C / -40 ... 80 °C</p> <p>Weight 10g</p>

Accessories	<p>Retaining clip, plastic for S7-P CP-07B</p> <p>Retaining clip, plastic for S7-L + S7-PO CP-01B</p>
--------------------	---



Printed circuit lay-out [mm]

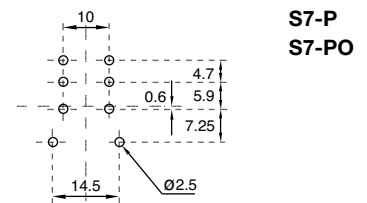

Dimensions [mm]

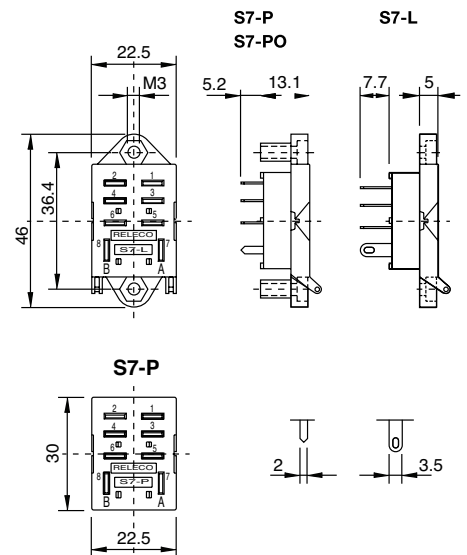

Technical approvals, conformities



EN 60947-1, EN 61810-1