

<b>Type</b>	<p><b>S10</b></p> <p>1-pole, 1 connection level</p> <p>Logic wiring</p> <p>Integrated retaining clip and labelling space</p> <p>Coil bridge bar for A2, 11</p>
<b>Rated current</b>	<b>10 A</b>
<b>Specifications</b>	<p>Rated load 10 A / 250 V</p> <p>Insulation Test voltage V rms / 1 min 5 kV</p> <p>– All terminals/DIN rail 5 kV</p> <p>Contact terminals 2,5 kV</p> <p>Contact / Coil terminals 5 kV</p> <p>Cross-section of connecting wire</p> <p>– Single-wire 4 mm<sup>2</sup> or 2 x 2,5 mm<sup>2</sup></p> <p>– Multi-wire 22 - 14 AWG</p> <p>Max. screw torque 1,2 Nm</p> <p>Screw dimensions M3, Pozi, slot</p> <p>Integrated retaining clip/plastic for relay series C10, CSS (CP-17B)</p> <p>Labelling space detachable</p> <p>Connection label 1...5; DIN/EN</p> <p>Mounting DIN rail TS35 or mounting plate</p> <p>Ambient temperature operation/storage -40 (no ice)...60 °C / -40 ... 80 °C</p> <p>Weight 23g</p>



<b>Socket for plug-in 10A IRC relays</b>	<b>C10-A, C10-T, CSS, C10-G</b>
--	---------------------------------

<b>Accessories</b>	<b>S10-BB</b>
Coil bridge bars	<b>CP-17B</b>
Retaining clip, plastic	

**Connection diagram**

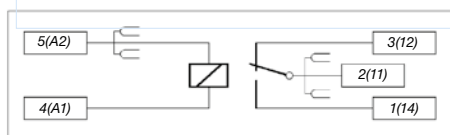

**Dimensions [mm]**

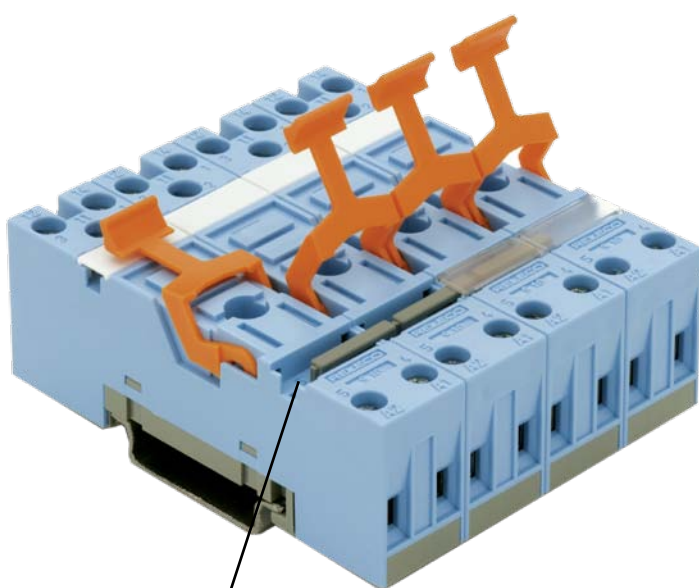
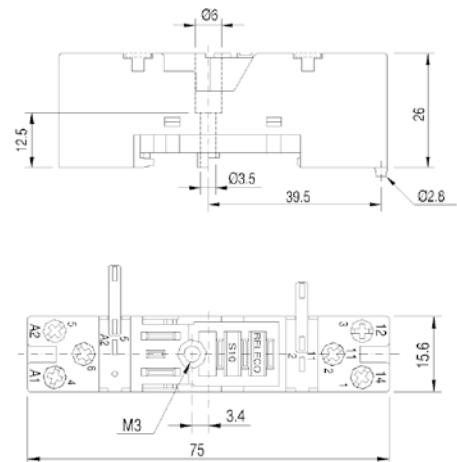

BRIDGE BAR

**Technical approvals, conformities**



EN 60947-1, EN 61810-1

# S10-M

## Socket for Interface relay

<b>Type</b>	<b>S10-M</b> I/O socket for IRC relays, 16 A Logic connection , 2 x A2
<b>Rated current</b>	<b>16 A</b>
<b>Specifications</b>	
Rated load	16 A / 250 V
Insulation	Test voltage V rms / 1 min
- All terminals/DIN rail	5 kV
Contact / Coil terminals	5 kV
Cross-section of connecting wire	
- Single-wire	4 mm <sup>2</sup> or 2 x 2,5 mm <sup>2</sup>
- Multi-wire	22 - 14 AWG
Max. screw torque	1,2 Nm
Screw dimensions	M3, Pozi, slot
Integrated retaining clip/plastic	for relay series C10, CSS (CP-17B)
Labelling space	detachable
Connection label	1...6; DIN/EN
Mounting	DIN rail TS35 or mounting plate
Ambient temperature operation/storage	-40 (no ice)...60 °C / -40 ... 80 °C
Weight	25g

<b>Socket for plug-in 10A IRC relays</b>	<b>C10A, C10G, C10T and CSS</b>
<b>Accessories</b>	
Coil bridge bars	<b>V10-G, V40-G, V10-R, V40-R, V10-A, V40-A, B20-G, B20-R, B20-A, CP-17B</b>
Retaining clip, plastic	

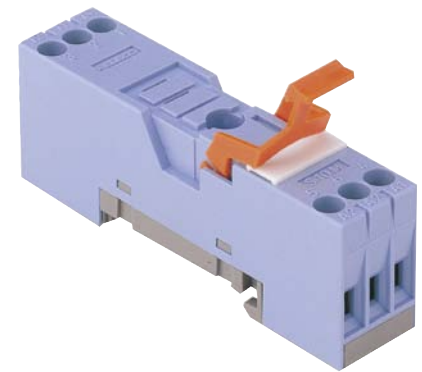

### Connection diagram

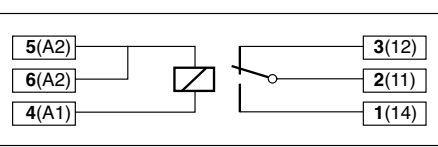

### Dimensions [mm]

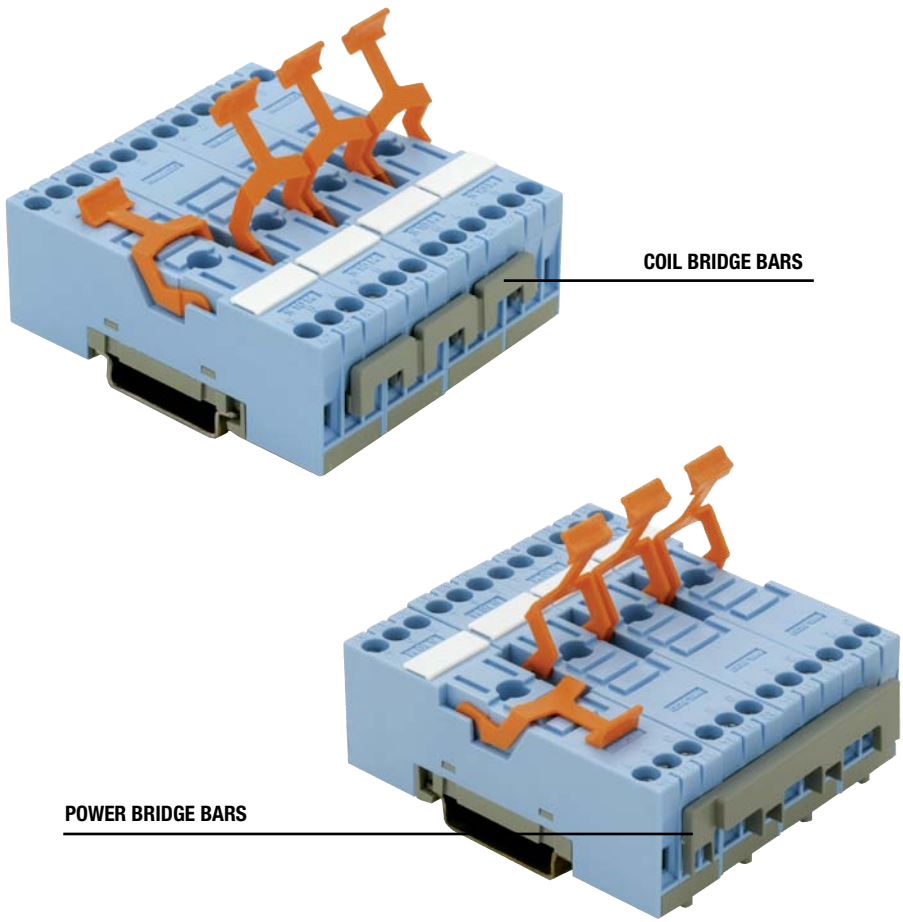
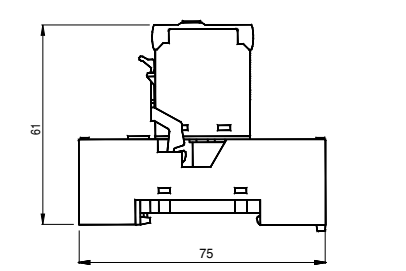
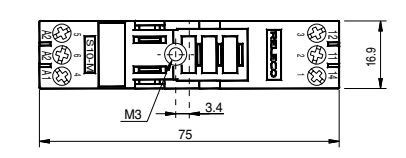
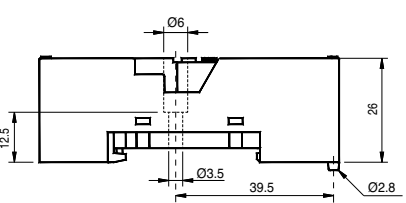

### Technical approvals, conformities



IEC 61810 EN 60947

# S10-P

## Printed circuit socket for Interface relays, C10 and CSS

<b>Type:</b>	<b>S10-P</b> Printed circuit socket for 1-pole IRC relay
<b>Rated current</b>	<b>10 A</b>
<b>Specifications</b>	
Rated load	10 A / 250 V
Insulation	Test voltage V rms / 1 min
Coil terminals to contacts	5 kV rms
Hard Brass tin-plated terminals	0,5 x 1 mm
Integrated retaining clip/plastic	for relay series C10, CSS (CP-24B)
Labelling space	detachable
Connection label	1...5; DIN/EN
Ambient temperature operation/storage	-40 (no ice)...60 °C / -40 ... 80 °C
Weight	7g
<b>Accessories</b>	
Retaining clip, plastic	<b>CP-24B</b>



### Dimensions [mm]

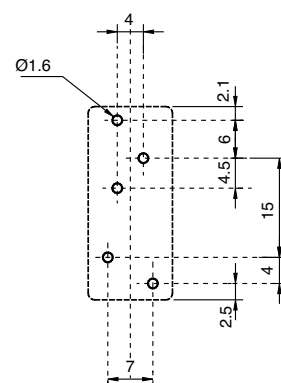
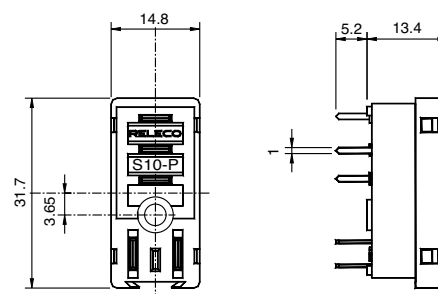

### Technical approvals, conformities



IEC 61810 EN 60947