



- *Wide-spectrum RGB LED emission*
- *3 different versions: basic, standard and enhanced*
- *Automatic, manual and dynamic setting*
- *15, 20 or 30 kHz switching frequency*
- *NPN/PNP and analogue outputs*
- *Standard fixing, M12 connector rotatable on 5 positions*

## TL46 SERIES

The new digital contrast sensor line of the **TL46** series is characterised by excellent performances in terms of resolution, definition and precision of the light spot emitted by RGB LEDs, low response time and high switching speed. The sensor, developed in a sturdy metal housing with standard fixing, is available in 3 different versions able to better satisfy all applications offering avantgarde technology at the best price/performance ratio. The **TL46-W** basic version has only one set push-button, 2 LEDs indicating respectively the output status and sensor acquisition condition. The performances and use ease have been optimised and offered at a competitive price.

The **TL46-WL** standard version has set 3 push-buttons, 4 LEDs signalling the output status, sensor acquisition condition, delay output activation and push-button activation. A bargraph is also available for manual setting of the threshold to detect particularly difficult contrasts. The standard version supplies excellent performances in general at a 20 kHz switching frequency.

The **TL46-WLF** enhanced version presents a 4-digit display for the setting of the most advanced functions, such as dynamic acquisition of the contrast mark. The sensor reaches the maximum market performances at 30 kHz switching frequency. Accessory lenses with 9 - 40 mm focal distance are available for all versions, as well as a high-resolution focussing lens and a PMMA plastic patent-covered lens particularly suitable to food applications with standard 9 mm focal distance.

## SETTING

The switching threshold is set pressing twice the SET push-button; the first for the mark the second for the background.

The threshold level can be set manually, in the TL46-WL/WLF version, pressing the '+' and '-' push-buttons which increase or reduce the threshold as visualised on the bargraph or display.

The dynamic setting, present in the TL46-WLF version, detects the moving mark by simply keeping the SET push-button pressed, or activating the Remote/Dyn input.

## DIMENSIONS

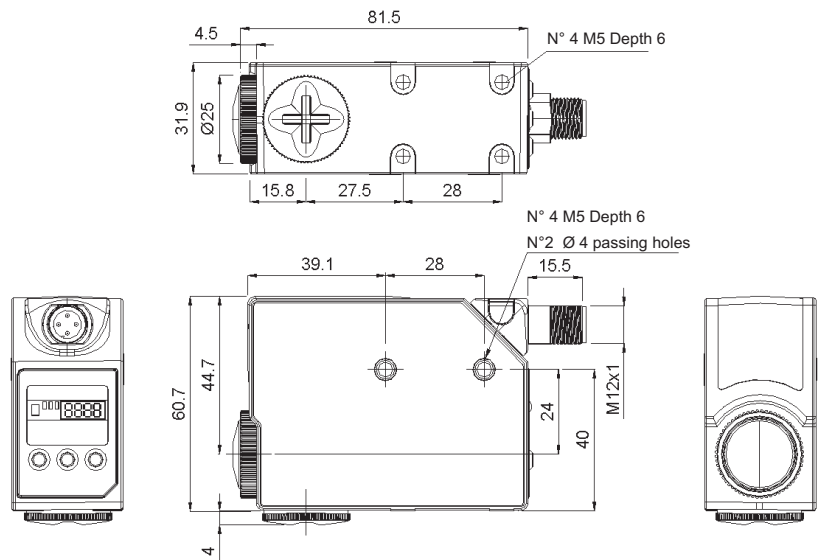

mm

## INDICATORS AND PUSH-BUTTONS

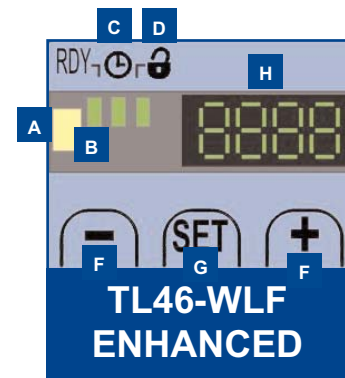
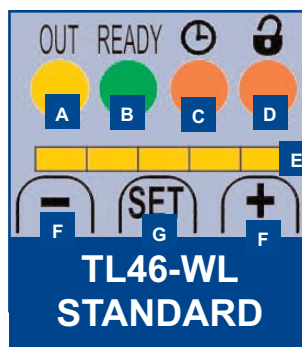
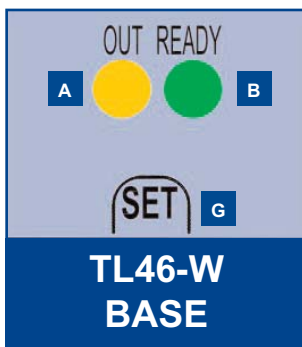

- A** yellow OUTPUT LED
- B** green READY LED
- C** orange DELAY LED
- D** orange KEYLOCK LED
- E** Bargraph
- F** +/- push-buttons
- G** SET push-button
- H** Display

## CONNECTIONS

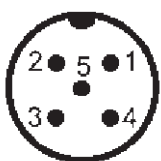

M12 CONNECTOR

VERSION	PIN 1 (brown)	PIN 2 (white)	PIN 3 (blue)	PIN 4 (black)	PIN 5 * (grigio)
TL46-W Base	+10...30Vdc	1...5.5Vdc output	0Vdc	NPN/PNP output	Delay
TL46-WL Std.	+10...30Vdc	1...5.5Vdc output	0Vdc	NPN/PNP output	Remote
TL46-WLF Enh.	+10...30Vdc	Dark/Light Dyn.	0Vdc	NPN/PNP output	Remote/Dyn.

\* A M12 4-pole connector can be used if the PIN5 function is not necessary.



## TECHNICAL DATA

		TL46-W-815	TL46-W-815L	TL46-WL-815	TL46-WL-815L	TL46-WLF-815	TL46-WLF-815L
<b>Power supply:</b>	10 ... 30 Vdc <sup>1</sup> , reverse polarity protection	●	●	●	●	●	●
<b>Consumption:</b>	85 mA max.	●	●	●	●	●	●
<b>Light emission:</b>	RGB LED (630nm red, 520nm green, 465nm blue) <sup>2</sup>	●	●	●	●	●	●
<b>Spot dimension:</b>	1.5 x 5 mm (with standard 9 mm lens)	●	●	●	●	●	●
<b>Spot orientation:</b>	horizontal		●		●		●
	vertical	●	●	●	●	●	●
<b>Operating distance:</b>	6 ... 12 mm (with standard 9 mm lens)	●	●	●	●	●	●
<b>Depth of field:</b>	± 3 mm (with standard 9 mm lens)	●	●	●	●	●	●
<b>Setting:</b>	automatic	●	●				
	automatic / manual / remote			●	●		
	automatic / manual / remote / dynamic					●	●
<b>Indicators:</b>	yellow OUTPUT LED	●	●	●	●	●	●
	green READY LED	●	●	●	●	●	●
	orange DELAY LED			●	●	●	●
	orange KEYLOCK LED			●	●	●	●
	5-segment bargraph			●	●		
	4-digit display					●	●
<b>Output type:</b>	NPN/PNP programmable	●	●	●	●	●	●
<b>Output current:</b>	100 mA max.	●	●	●	●	●	●
<b>Saturation voltage:</b>	≤ 2 V	●	●	●	●	●	●
<b>Response time:</b>	33 μs	●	●				
	25 μs			●	●		
	17 μs					●	●
<b>Switching frequency:</b>	15 kHz	●	●				
	20 kHz			●	●		
	30 kHz					●	●
<b>Operating mode:</b>	dark/light selectable	●	●	●	●	●	●
<b>Analogue output:</b>	1 ... 5.5 V (3 V on 90% white)	●	●	●	●	●	●
<b>Timing function:</b>	20 ms programmable	●	●	●	●	●	●
	0 ... 100 ms programmable					●	●
<b>Auxiliary functions:</b>	keylock			●	●		
	fine hysteresis regulation					●	●
<b>Connections:</b>	M12 5-pole connector <sup>3</sup>	●	●	●	●	●	●
<b>Electrical protection:</b>	class 2, double insulation	●	●	●	●	●	●
<b>Mechanical protection:</b>	IP67	●	●	●	●	●	●
<b>Protection devices:</b>	A, B <sup>4</sup>	●	●	●	●	●	●
<b>Housing material:</b>	aluminum	●	●	●	●	●	●
<b>Lens material:</b>	PMMA	●	●				
	glass			●	●	●	●
<b>Weight:</b>	170 g max.	●	●	●	●	●	●
<b>Operating temperature:</b>	-10...55°C	●	●	●	●	●	●
<b>Storage temperature:</b>	-20...70°C	●	●	●	●	●	●
<b>Reference standard:</b>	EN 60947-5-2	●	●	●	●	●	●

## VERTICAL SPOT



## HORIZONTAL SPOT



Horizontal spot is present in the TL46 models with final '-L' suffix

## TECHNICAL NOTES

- Limit values
- Average life of 100.000 h with  $T_A = +25^\circ\text{C}$
- Connector block rotatable on 5 positions
- A - reverse polarity protection  
B - overload and short-circuit protection



## DETECTION DIAGRAMS

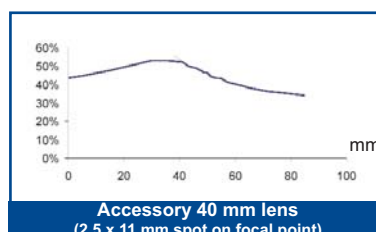
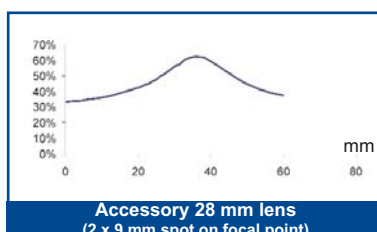
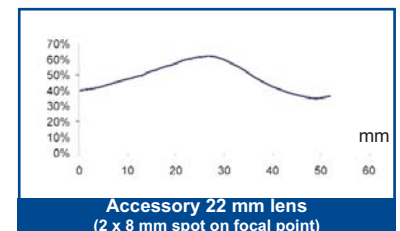
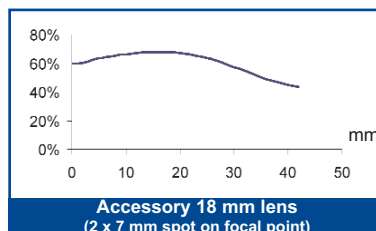
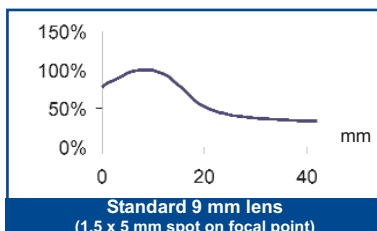

## MODEL SELECTION AND ORDER INFORMATION

MODEL	VERSION	SPOT	ORDER N°
TL46-W-815	basic	vertical	954601000
TL46-W-815L	basic	horizontal	954601010
TL46-WL-815	standard	vertical	954601020
TL46-WL-815L	standard	horizontal	954601030
TL46-WLF-815	enhanced	vertical	954601040
TL46-WLF-815L	enhanced	horizontal	954601050

## ACCESSORY LENSES

### DIMENSIONS

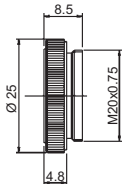

Lens No.9 glass

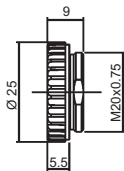

Lens No.9 PMMA

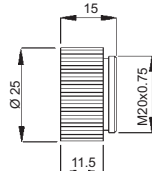

Lens HI-RES glass

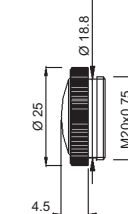

Lens 18 mm glass

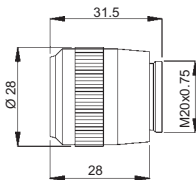

Lens 22 mm glass

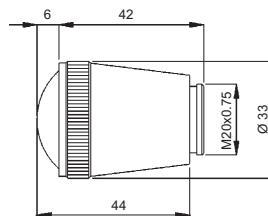

Lens 28 mm glass

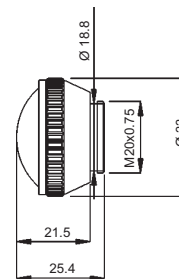

Lens 40 mm glass

mm

## ACCESSORY SELECTION AND ORDER INFORMATION

MODEL	DESCRIPTION	ORDER N°
CS-A1-03-G-03	axial M12 NO-NC 5-poles 3 m	95ACC2110
CS-A1-03-G-05	axial M12 NO-NC 5-poles 5 m	95ACC2120
CS-A1-03-G-10	axial M12 NO-NC 5-poles 10 m	95ACC2140
Lens No.9 glass	glass lens with 9 mm focus	95ACC2670
Lens No.9 PMMA	plastic lens with 9 mm focus	95ACC2540
Lens Hi-Res glass	additional focussing glass lens (*)	95ACC1050
Lens No.18 glass	glass lens with 18 mm focus	95ACC2680
Lens No.22 glass	glass lens with 22 mm focus	95ACC1100
Lens No.28 glass	glass lens with 28 mm focus	890000194
Lens No.40 glass	glass lens with 40 mm focus	95ACC2740

\* focussing lens to screw between the sensor and normal 9 mm lens to reduce the light spot dimension and increase resolution

Please refer also to **Sensor Accessories**



Distributed by:

### HEADQUARTERS

**DATASENSOR SpA**  
via Lavino, 265 - 40050 Monte San Pietro, BO - Italy  
Tel. +39 051/6765611 • Fax +39 051/6759324  
www.datasensor.com • e-mail info@datasensor.com

Datasensor SpA endeavours to continuously improve and renew its products; for this reason the technical data and contents of this catalogue may undergo variations without prior notice. For correct installation and use Datasensor SpA can guarantee only the data indicated in the instruction manual supplied with the products.